

DIAPHRAGM SENSING PRESSURE REDUCING VALVES PRV30SS (1" to 2" – DN 25 to DN 50)

DESCRIPTION

The ADCA PRV30SS is a series of direct acting, spring-loaded, diaphragm sensing and balanced plug pressure reducing valves. These regulators are designed for use with compressed air, water and other gases and liquids compatible with the construction materials and valve design.

They are suitable for pressure reducing applications at the point of use in laundry and dyeing machines, food industries, sterilizers, etc.

MAIN FEATURES

- Compact design.
- Built-in strainer.
- Balanced valve plug.
- Full stainless steel construction.
- Various sealing options to meet compatibility requirements.

- OPTIONS:**
- Self relieving.
 - Gauge connection on body.
 - Different soft valves for liquids and gases.
 - Dome-loaded version.
 - Top cap (adjustment screw with cover).
 - Degreased for oxygen application.

USE: Compressed air, water and other gases and liquids compatible with the construction.

AVAILABLE MODELS: PRV30SS – stainless steel, diaphragm sensing.

SIZES: 1" to 2"; DN 25 to DN 50.

CONNECTIONS: Female threaded ISO 7 Rp or NPT (only available from 1 1/4" to 2").
Flanged EN 1092-1 PN 40 (only available from DN 32 to DN 50) or PN 63.
Flanged ASME B16.5 Class 150 or 300 (only available from 1 1/4" to 2") or Class 600.

INSTALLATION: Horizontal installation.
See IMI – Installation and maintenance instructions.



CE MARKING – GROUP 2 (PED – European Directive)

Class 150	PN 40 / PN 63 Class 300 / Class 600	Category
1" to 2" DN 25 to 50	1" and 1 1/4" DN 25 and DN 32	SEP
–	1 1/2" and 2" DN 40 and DN 50	1

FLOW RATE COEFFICIENTS (m³/h)

SIZE	1" DN 25	1 1/4" DN 32	1 1/2" DN 40	2" DN 50
Kvs	6,5	7,2	12,7	13,7

LIMITING CONDITIONS

Valve model	PRV30SS				
Body design conditions	Cl. 150	Cl. 300	Cl. 600	PN 40	PN 63 *
Max. upstream pressure	16 bar	40 bar	50 bar	40 bar	50 bar
Max. downstream pressure	15 bar				
Min. downstream pressure	0,2 bar				
Max. design temperature	80 °C				
Max. recommended reducing ratio	40:1				
Max. dome-loading pressure	15 bar				

* Rating PN 63 for threaded versions.

OPTIONS		
PRESSURE GAUGE CONNECTION	TOP CAP	DOME-LOADED VERSION

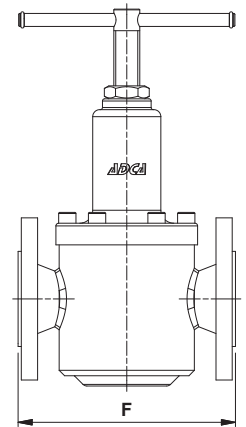
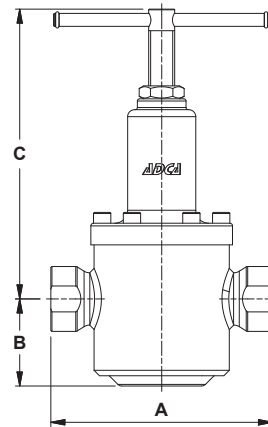
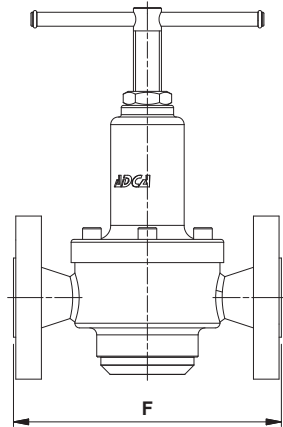
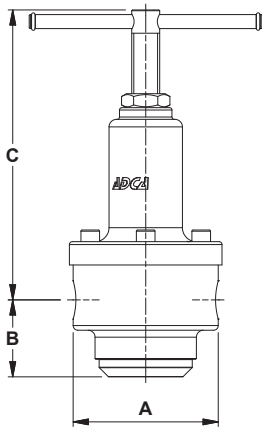

1" to 1 1/4" – DN 25 to DN 32

1 1/2" to 2" – DN 40 to DN 50

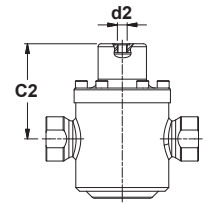
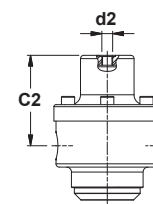
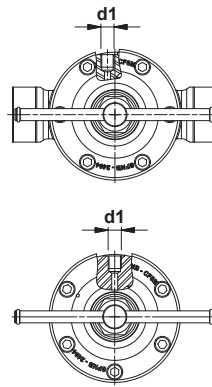
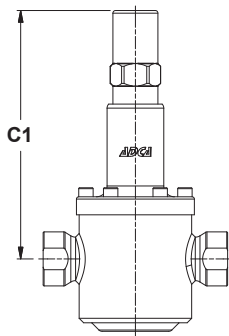
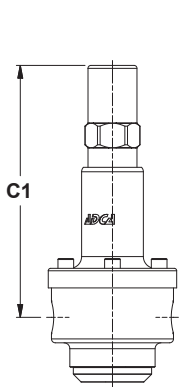

Optional top cap

Optional pressure gauge connection

Optional dome-loaded version

DIMENSIONS (mm)																		
SIZE	THREADED				PN 40		PN 63		CLASS 150		CLASS 300		CLASS 600					
	A	B	C	C1	d1	C2	d2	WGT. (kg)	F *	WGT. (kg)	F *	WGT. (kg)	F *	WGT. (kg)	F *	WGT. (kg)	F *	WGT. (kg)
1" – DN 25 **	125	66	249	257	1/4"	110	1/4"	–	–	–	230	14,1	–	–	–	–	230	12,5
1 1/4" – DN 32	125	66	249	257	1/4"	110	1/4"	8,7	260	12,6	260	14,9	260	11,7	260	12,8	260	13,6
1 1/2" – DN 40	205	81	268	276	1/4"	129	1/4"	12,4	201	16,3	260	20,1	235	15,9	248	18,1	264	19,2
2" – DN 50	205	75	274	270	1/4"	123	1/4"	13,2	230	18,2	300	21,3	254	16,7	267	18,6	300	21

* Different face to face dimensions on request; ** Only available with PN 63 and Class 600 flanged connections.

Remarks: As standard, in versions manufactured with EN 1092-1 flanges or ISO 7 Rp threads, connections d1 and d2 are female threaded ISO 7 Rp. In versions with ASME B16.5 flanges or NPT threads, these connections are female threaded NPT.

MATERIALS

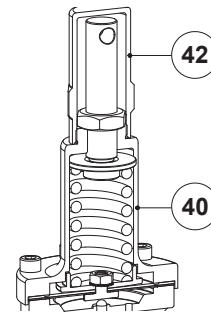
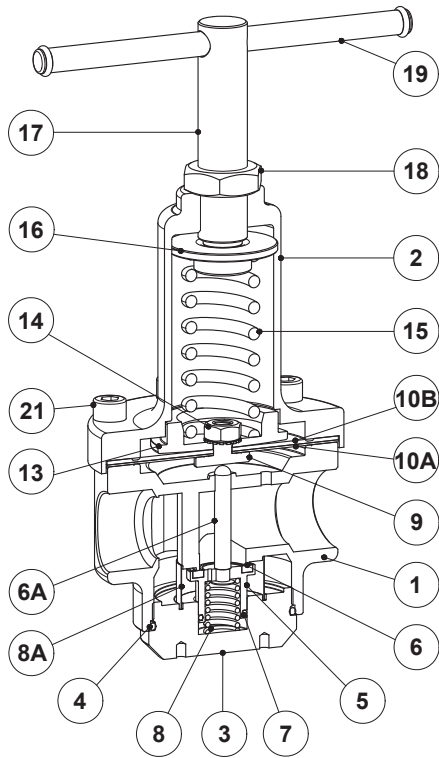

Optional top cap

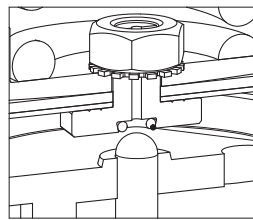

Optional relieving version

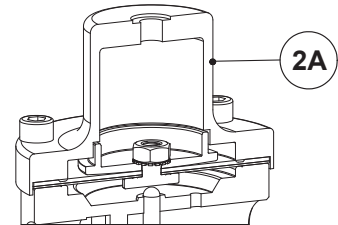

Optional dome-loaded version

1" and 1 1/4" – DN 25 and DN 32

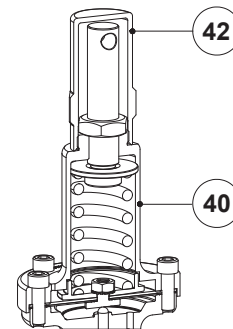
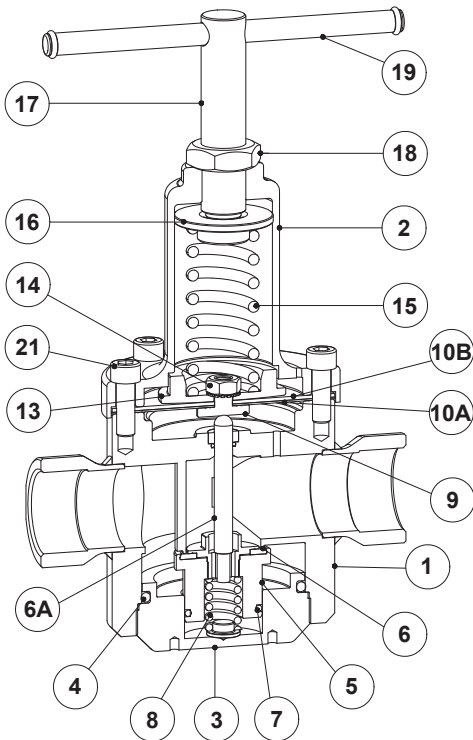

Optional top cap

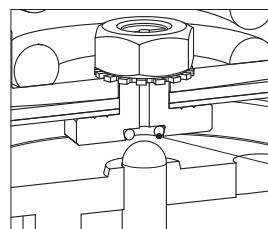

Optional relieving version

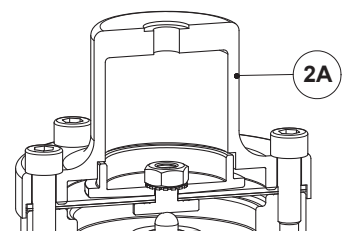

Optional dome-loaded version

1 1/2" and 2" – DN 40 and DN 50

MATERIALS			
POS. N°	DESIGNATION	1" and 11/4" – DN 25 and DN 32	11/2" and 2" – DN 40 and DN 50
1	Valve body	AISI 316 / 1.4401	AISI 316 / 1.4401
2	Spring cover	A351 CF8M / 1.4408	A351 CF8M / 1.4408
2A	Cover	AISI 316 / 1.4401	AISI 316 / 1.4401
3	Bottom cover	AISI 316 / 1.4401	AISI 316 / 1.4401
4	* O-ring	NBR; EPDM; PTFE; FPM	NBR; EPDM; PTFE; FPM
5	* Piston	AISI 316 / 1.4401	AISI 316 / 1.4401
6	* Valve head	NBR; EPDM; PTFE; FPM	NBR; EPDM; PTFE; FPM
6A	* Pushrod	AISI 316 / 1.4401	AISI 316 / 1.4401
7	* Piston o-ring	NBR; EPDM; FPM	NBR; EPDM; FPM
8	* Valve spring	AISI 302 / 1.4300	AISI 302 / 1.4300
8A	* Strainer screen	AISI 304 / 1.4301	–
9	Pusher disc	AISI 304 / 1.4301	AISI 304 / 1.4301
9A	* O-ring	NBR; EPDM; FPM	NBR; EPDM; FPM
10A	* Lower diaphragm	PTFE	PTFE
10B	* Upper diaphragm	NBR	NBR
13	Spring plate	AISI 304 / 1.4301	AISI 304 / 1.4301
14	Nut	Stainless steel A2-70	Stainless steel A2-70
15	* Adjustment spring	AISI 302 / 1.4300	AISI 302 / 1.4300
16	Top spring plate	Brass	Brass
17	Adjustment stem	AISI 304 / 1.4301	AISI 304 / 1.4301
18	Locknut	Stainless steel A2-70	Stainless steel A2-70
19	Handwheel	AISI 304 / 1.4301	AISI 304 / 1.4301
21	Bolts	Stainless steel A2-70	Stainless steel A2-70
40	Cover	AISI 316L / 1.4404	A351 CF8M / 1.4408
42	Top cap	AISI 316L / 1.4404	AISI 316L / 1.4404

* Available spare parts.

Remark: All valves have a serial number. In case of non-standard valves this number must be supplied if spare parts are ordered.

ORDERING CODES PRV30SS													
Valve model	R30	.	1	W	N	C	R	4	R	.	A	32	
PRV30SS – diaphragm sensing pressure reducing valve	R30												
Regulating range													
N° 1 – 0,2 to 1,5 bar			1										
N° 2 – 0,3 to 3 bar			2										
N° 3 – 0,8 to 8 bar			3										
N° 4 – 1,5 to 15 bar			4										
0,2 to 15 bar (dome-loaded) a)			A										
Application													
Water				W									
Gases				G									
Oxygen (degreased)				O									
Seal material													
NBR					N								
EPDM					E								
PTFE b)					T								
FPM / Viton					V								
Maximum inlet pressure													
30 bar						C							
50 bar c)						D							
Diaphragm													
NBR / PTFE (only NBR in case of dome-loaded version)							R						
Gauge port options													
Without gauge ports										(1)			
Gauge port on the left side (relative to the flow direction)										4			
Gauge port on the right side (relative to the flow direction)										3			
Gauge ports on both sides										2			
Top cap and relieving													
Non-relieving											(1)		
Relieving (only for non-dangerous gases)											R		
Non-relieving with top cap (adjustment screw with cover)											T		
Relieving with top cap (adjustment screw with cover, only for non-dangerous gases)											V		
Dome-loaded top d)											X		
Pipe connection													
Female threaded ISO 7 Rp												A	
Female threaded NPT ASME B1.20.1												C	
Flanged EN 1092-1 PN 40												N	
Flanged EN 1092-1 PN 63												O	
Flanged ASME B16.5 Class 150												U	
Flanged ASME B16.5 Class 300												V	
Flanged ASME B16.5 Class 600												W	
Size													
1" or DN 25 (only available with PN 63 and Class 600 flanged connections)													25
1 1/4" or DN 32													32
1 1/2" or DN 40													40
2" or DN 50													50
Special valves / Extras													
Full description or additional codes have to be added in case of non-standard combination.													E

(1) Omitted if a standard valve is requested.

a) The loading control pressure can be up to a maximum of 1,2 bar above the required downstream pressure.

b) All seals except piston o-ring, which is supplied in FPM/Viton or others on request.

c) Only available with spring n° 4.

d) This option must be chosen in case of dome-loaded version.